

# DOLOROSA



## Agony in the Garden

*Primary:* Matthew 26:36-46; Mark 14:32-42; Luke 22:39-46

*Enriching:* John 17:1-26; Matthew 26:69-75; Mark 14:66-72; Luke 22:54-62; John 18:12-16; Romans 13:11-14; Ephesians 5:19-20; 1 Thessalonians 5:6-11

## Scourging at the Pillar

*Primary:* Matthew 27:24-26; Mark 15:6-15; John 19:1

*Enriching:* Isaiah 53:1-12; John 15:18-16:4a

## Crowning with Thorns

*Primary:* Matthew 27:27-31; Luke 23:11; Mark 15:16-20; John 19:2-11

*Enriching:* John 18:28-39; Psalm 74:14-16; Psalm 102:8-11

## Carrying the Cross

*Primary:* Matthew 27:31-32; Mark 15:20-21; Luke 23:26-31; John 19:17

*Enriching:* John 16:20-22; Psalm 38:4; Matthew 11:28-30; Luke 9:23-25

## Crucifixion and Death

*Primary:* Matthew 27:33-66; Mark 15:22-47; Luke 23:27-56; John 19:17-42

*Enriching:* John 2:13-25; John 3:13-17; Philippians 2:5-11; Colossians 1:15-24; Psalm 22; Psalm 31:5; Psalm 34:20; Psalm 69:21; Psalm 109:25; Exodus 12:46; Exodus 26:31-35; Numbers 21:4b-9; Zechariah 12:10-13:1; Acts 7:59-60

## Baptism of Jesus

*Primary:* Matthew 3:13-17; Mk. 1:1-11; Lk. 3:21-22; John 1:19-34

*Enriching:* Matthew 3:1-17; 2 Kings 2:1-14; Mt. 11:14; Mal. 4:5; Mark 10:35-45; Romans 6:1-14; Romans 8:1-14; 17; Psalm 51:10

## Wedding Feast at Cana

*Primary:* John 2:1-11

*Enriching:* Revelation 19:5-10; 1 Kings 2:13-21; John 6:4-14; John 13:1; Matthew 26:26-28; Genesis 2:18-24

## Proclamation of the Kingdom

*Primary:* Mark 1:14-15; Luke 4:16-19; 31-44

*Enriching:* Matthew 5:1-12; Matthew 6:2-7; Luke 9:37-43; Luke 12:22-34; Luke 13:18-20; Luke 17:20-21; Mark 10:13-16; John 17:20-26

## Transfiguration

*Primary:* Luke 9:28-36; Matthew 17:1-8; Mark 9:2-10

*Enriching:* 2 Peter 1:17-18; Ex. 24:9-18; 34:29-30; Deut. 18:15-18; Malachi 4:4-5

## Institution of the Eucharist

*Primary:* Matthew 26:17-29; Mark 14:12-25; Luke 22:1-23; John 13:1-20

*Enriching:* John 6:25-71; 1 Corinthians 11:23-34; Exodus 12:1-14; Genesis 14:17-20; 1 Corinthians 5:7-8; Exodus 24:1-11

# LUCE SONNIMUS

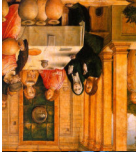

# GLORIOSA

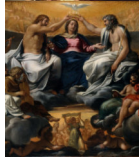

## Coronation of Mary Queen of Heaven & Earth

*Primary:* Revelation 11:19a, 12:1-6a, 10ab

*Enriching:* Matthew 2:9b-12

## Assumption of Mary

*Primary:* Luke 1:28,38; Luke 1:41-42; Genesis 3:15

*Enriching:* Luke 1:46-56; Luke 2:19; Luke 2:34-35; John 19:25-27; Psalm 45:10-12,16; 1 Corinthians 15:20-27

## Descent of the Holy Spirit

*Primary:* Acts 2:1-36; John 20:19-23

*Enriching:* John 14:22-25; John 16:4b-15; 1 Corinthians 12:3b-7,12-13; Psalm 104:1,24,29-31,34; Galatians 5:16-25

## Ascension

*Primary:* Matthew 28:16-20; Mark 16:14-20; Luke 24:50-53; Acts 1:6-11

*Enriching:* John 14:27-29; John 16:27-28; Ephesians 1:17-23; Hebrews 12:1-2; Psalm 47; Psalm 68:32-35

## Resurrection

*Primary:* Matthew 28:1-10; Mark 16:1-13; Luke 24:1-49; John 20:1-31,21:1-25

*Enriching:* John 12:24; 1 Corinthians 15:1-58; 1 Peter 1:18-20; Isaiah 25:8-9; Ezekiel 37:1-14

## Annunciation

*Primary:* Luke 1:26-38; Matthew 1:18-25

*Enriching:* Luke 1:5-25; Zephaniah 3:14-17; Daniel 2:43-45

## Visitation

*Primary:* Luke 1:39-56

*Enriching:* Luke 1:57-80; 1 Samuel 2:1-10

## Nativity

*Primary:* Matthew 2:1-12; Luke 2:1-21

*Enriching:* Matthew 2:13-23

## Presentation

*Primary:* Luke 2:22-38

*Enriching:* Leviticus 12:2-8; 1 Samuel 1:19-28

## Jesus in the Temple

*Primary:* Luke 2:41-52

*Enriching:* Isaiah 7:10-15; Isaiah 11:1-10



## Coronating Prayer

R. Ora digni efficiamur promissionibus Christi.  
V. Ora pro nobis sancta Dei Genetrix.  
dulcis Virgo Maria.  
nobis post hoc exilium ostende. O clemens, O pia, O ad nos converte. Et iesum, benedictum fructum ventris tui.  
Eia ergo, advocata nostra, illos tuos misericordes oculos suspiramus, gementes et flentes in hac lacrimarum valle.  
Salve, Regina, mater misericordiae; vita, dulcedo, et spes nostra, salve. Ad te clamamus, exules filli Evae. Ad te salutem, mater misericordiae; vita, dulcedo, et spes nostra, salve.  
Ora pro nobis sancta Dei Genetrix.  
R. Ut digni efficiamur promissionibus Christi.

## Our Father (Fatima Prayer)

O Jesu mi, ignosce nobis, libera nos ab igne inferni, ad caelum trahe omnes animas, praesertim maxime indigentes.

## Salve Regina (Hail, Holy Queen)

O Jesu mi, ignosce nobis, libera nos ab igne inferni, ad caelum trahe omnes animas, praesertim maxime indigentes.

Salve, Regina, mater misericordiae; vita, dulcedo, et spes nostra, salve. Ad te clamamus, exules filli Evae. Ad te salutem, mater misericordiae; vita, dulcedo, et spes nostra, salve.

Salve, Regina, mater misericordiae; vita, dulcedo, et spes nostra, salve. Ad te clamamus, exules filli Evae. Ad te salutem, mater misericordiae; vita, dulcedo, et spes nostra, salve.

Salve, Regina, mater misericordiae; vita, dulcedo, et spes nostra, salve. Ad te clamamus, exules filli Evae. Ad te salutem, mater misericordiae; vita, dulcedo, et spes nostra, salve.

Salve, Regina, mater misericordiae; vita, dulcedo, et spes nostra, salve. Ad te clamamus, exules filli Evae. Ad te salutem, mater misericordiae; vita, dulcedo, et spes nostra, salve.

Salve, Regina, mater misericordiae; vita, dulcedo, et spes nostra, salve. Ad te clamamus, exules filli Evae. Ad te salutem, mater misericordiae; vita, dulcedo, et spes nostra, salve.

Salve, Regina, mater misericordiae; vita, dulcedo, et spes nostra, salve. Ad te clamamus, exules filli Evae. Ad te salutem, mater misericordiae; vita, dulcedo, et spes nostra, salve.

Salve, Regina, mater misericordiae; vita, dulcedo, et spes nostra, salve. Ad te clamamus, exules filli Evae. Ad te salutem, mater misericordiae; vita, dulcedo, et spes nostra, salve.

Salve, Regina, mater misericordiae; vita, dulcedo, et spes nostra, salve. Ad te clamamus, exules filli Evae. Ad te salutem, mater misericordiae; vita, dulcedo, et spes nostra, salve.

# Rosary Prayers

## Doxology (Glory Be)

In nomine Patris, et Filii, et Spiritus Sancti. Amen.  
(Note: Make cross by touching with right hand — forehead [Patris], torso [Filii], left shoulder [Spiritus], right shoulder [Sancti])

## Symbolum Apostolorum (Apostles Creed)

Creo in Deum, Patrem omnipotentem, Creatorem caeli et terrae. Et in Iesum Christum, Filium eius unicum, Dominum nostrum: qui conceptus est de Spiritu Sancto, natus ex Maria Virgine, passus sub Pontio Pilato, crucifixus, mortuus, et sepultus; descendit ad inferos; tertia die resurrexit a mortuis; ascendit ad caelos; sedet ad dexteram Dei Patris omnipotentis; inde venturus est iudicare vivos et mortuos. Credo in Spiritum Sanctum, sanctam Ecclesiam Catholicam, Sanctorum communionem, remissionem peccatorum, carnis resurrectionem, vitam aeternam. Amen.

## Pater Noster (Our Father)

Pater noster, qui es in caelis: sanctificetur nomen tuum; adveniat regnum tuum; fiat voluntas tua, sicut in caelo, et in terra. Panem nostrum cotidianum da nobis hodie; et dimittite nobis debita nostra, sicut et nos dimittimus debitoribus nostris; et ne nos inducas in tentationem; sed libera nos a malo. Amen.

## Concluding Prayer

Per eundem Christum Dominum nostrum. Amen.  
Imitemur quod continent, et quod promittunt, assequamur. sacratissimo beatae Mariae Virginis Rosario recolentes, et comparati: concede, quaesumus: ut haec mysteria resurrectionem suam nobis salutis aeternae praemia Deus, cunctis Unigenitis per vitam, mortem et

Ave Maria, gratia plena, Dominus tecum: benedicta tu in mulieribus, et benedictus fructus ventris tui, Iesus. Sancta Maria, Mater Dei, ora pro nobis peccatoribus, nunc et in hora mortis nostrae. Amen.

# Steps

1. Begin by making the Sign of the Cross while holding the crucifix. Pray the Apostles' Creed.
2. Pray an Our Father.
3. Pray a Hail Mary on each of the three beads, asking for an increase in the Theological Virtues of Faith, Hope and Charity (Love).
4. Pray the Glory Be.
5. Announce or call to mind the first Mystery to meditate upon and pray an Our Father.
6. Pray one Hail Mary on each of the ten beads
7. Finish the decade by praying a Glory Be and the Fatima Prayer. (**Note:** steps 5-7 together are called a decade).
8. Repeat steps 5-7 for the next four decades, meditating on the remaining Mysteries.
9. Holding the center piece, pray the Hail, Holy Queen and the concluding Rosary prayer. Finish by making the Sign of the Cross.

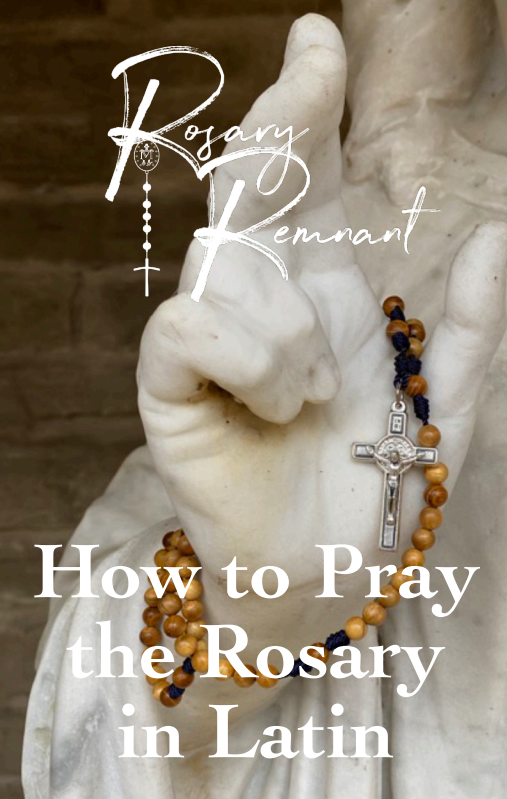

# How to Pray the Rosary in Latin

# Folding Instructions

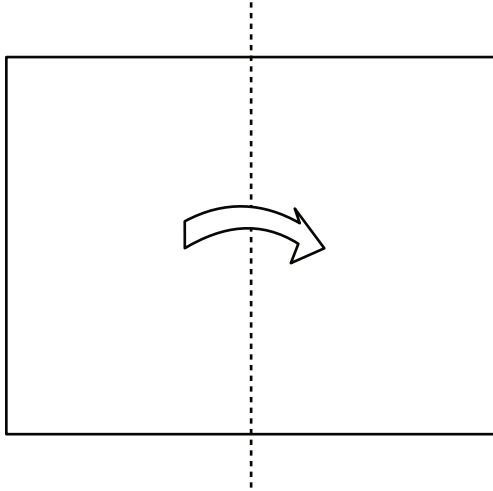

**Step 1** Fold paper in half in the middle of long edge of the paper

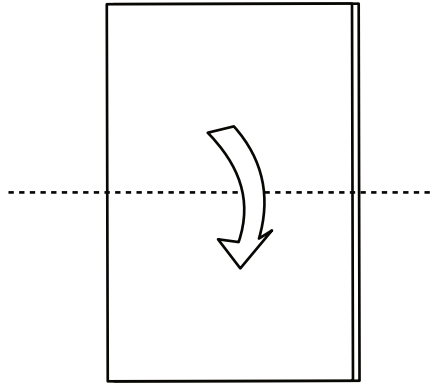

**Step 2** Fold the paper in half again in a downward direction

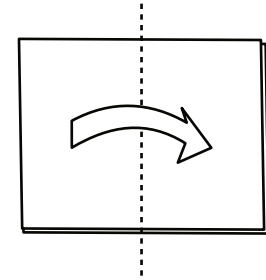

**Step 3** Fold the paper in half one more time as shown. The paper should be folded to one-eighth of the original size.

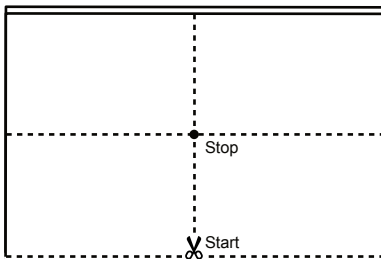

**Step 4** Unfold the paper to half the original size and turn the paper so the paper is open at top and the crease is at the bottom (the dotted lines represent the creases). Cut from the bottom of the paper to the middle (from the START to the STOP points shown above).

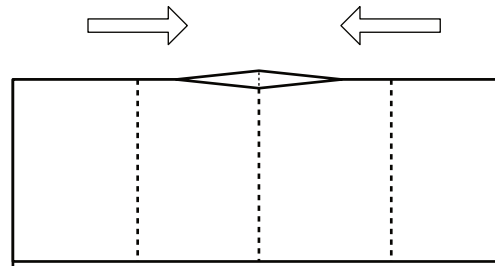

Side View

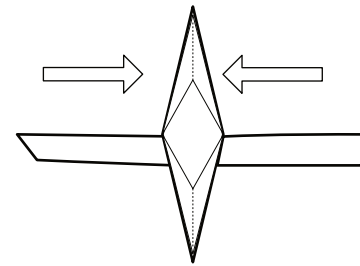

Top View

**Step 5** Unfold the paper completely and refold in half along the short edge as shown. Push the paper inward so that the inside faces touch. It will look like a “plus sign” (+) if done correctly. The creases should form a booklet spine along the left edge.

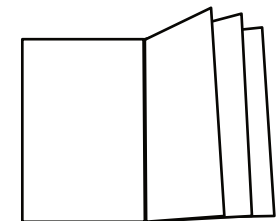

You now have a Rosary Instructions mini booklet to put in your pocket, place in a book, or give away!