

SORROWFUL



Agony in the Garden

Primary: Matthew 26:36-46; Mark 14:32-42; Luke 22:39-46

Enriching: John 17:1-26; Matthew 26:69-75; Mark 14:66-72; Luke 22:54-62; John 18:12-16; 9; Romans 13:11-14; Ephesians 5:19-20; 1 Thessalonians 5:6-11

Scourging at the Pillar

Primary: Matthew 27:24-26; Mark 15:6-15; John 19:1

Enriching: Isaiah 53:1-12; John 15:18-16:4a

Crowning with Thorns

Primary: Matthew 27:27-31; Luke 23:11; Mark 15:16-20; John 19:2-11

Enriching: John 18:28-39; Psalm 7:14-16; Psalm 102:8-11

Carrying the Cross

Primary: Matthew 27:31-32; Mark 15:20-21; Luke 23:26-31; John 19:17

Enriching: John 16:20-22; Psalm 38:4; Matthew 11:28-30; Luke 9:23-25

Crucifixion and Death

Primary: Matthew 27:33-66; Mark 15:22-47; Luke 23:27-56; John 19:17-42

Enriching: John 2:13-25; John 3:13-17; Philippians 2:5-11; Colossians 1:15-24; Psalm 22; Psalm 31:5; Psalm 34:20; Psalm 69:21; Psalm 109:25; Exodus 12:46; Exodus 26:31-35; Numbers 21:4b-9; Zechariah 12:10-13:1; Acts 7:59-60

Baptism of Jesus

Primary: Matthew 3:13-17; Mk. 1:1-11; Lk. 3:21-22; John 1:19-34

Enriching: 2 Cor. 5:21; Joshua 3:17-17; 2 Kings 2:1-14; Mal. 4:5; Mark 10:35-45; Romans 6:1-14; Romans 8:14-17; Psalm 51:10

Wedding Feast at Cana

Primary: John 2:1-11

Enriching: Revelation 19:5-10; 1 Kings 2:13-21; John 6:4-14; John 13:1; Matthew 26:26-28; Genesis 2:18-24

Proclamation of the Kingdom

Primary: Mark 1:14-15; Luke 4:16-19; 31-44

Enriching: Matthew 5:1-12; Matthew 6:27-34; Luke 9:57-62; Luke 12:22-34; Luke 13:18-20; Luke 17:20-21; Mark 10:13-16; John 17:20-26

Transfiguration

Primary: Luke 9:28-36; Matthew 17:1-8; Mark 9:2-10

Enriching: 2 Peter 1:17-18; Ex. 24:9-18; 34:29-30; Deut. 18:15-18; Malachi 4:4-5

Institution of the Eucharist

Primary: Matthew 26:17-29; Mark 14:12-25; Luke 22:1-23; John 13:1-20

Enriching: John 6:25-71; 1 Corinthians 11:23-34; Exodus 12:1-14; Genesis 14:1-20; 1 Corinthians 5:7-8; Exodus 24:1-11

GLORIOUS

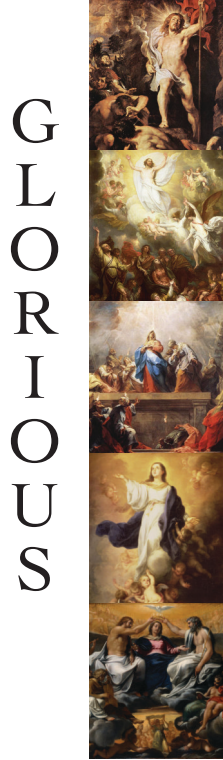

Resurrection

Primary: Matthew 28:1-10; Mark 16:1-13; Luke 24:1-49; John 20:1-31,21:1-25

Enriching: John 12:24; 1 Corinthians 15:1-58; 1 Peter 1:18-20; Isaiah 25:8-9; Ezekiel 37:1-14

Ascension

Primary: Matthew 28:16-20; Mark 16:14-20; Luke 24:50-53; Acts 1:6-11

Enriching: John 14:27-29; John 16:27-28; Ephesians 1:17-23; Hebrews 12:1-2; Psalm 47; Psalm 68:32-35

Descent of the Holy Spirit

Primary: Acts 2:1-36; John 20:19-23

Enriching: John 14:22-25; John 16:4b-15; 1 Corinthians 12:3b-7,12-13; Psalm 104:1,24,29-31,34; Galatians 5:16-25

Assumption of Mary

Primary: Luke 1:28,38; Luke 1:41-42; Genesis 3:15

Enriching: Luke 1:46-56; Luke 2:19; Luke 2:34-35; John 19:25-27; Psalm 45:10-12,16; 1 Corinthians 15:20-27

Coronation of Mary Queen of Heaven & Earth

Primary: Revelation 11:19a,12:1-6a,10ab

Enriching: Matthew 2:9b-12

Annunciation

Primary: Luke 1:26-38; Matthew 1:18-25

Enriching: Luke 1:5-25; Zephaniah 3:14-17; Daniel 2:43-45

Visitation

Primary: Luke 1:39-56

Enriching: Luke 1:57-80; 1 Samuel 2:1-10

Nativity

Primary: Matthew 2:1-12; Luke 2:1-21

Enriching: Matthew 2:13-23

Presentation

Primary: Luke 2:22-38

Enriching: Leviticus 12:2-8; 1 Samuel 1:19-28

Jesus in the Temple

Primary: Luke 2:41-52

Enriching: Isaiah 7:10-15; Isaiah 11:1-10

JOYFUL

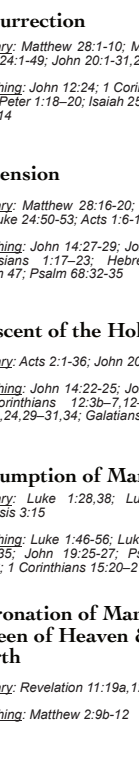

Steps

1. Begin by making the Sign of the Cross while holding the crucifix. Pray the Apostles' Creed.
2. Pray an Our Father.
3. Pray a Hail Mary on each of the three beads, asking for an increase in the Theological Virtues of Faith, Hope and Charity (Love).
4. Pray the Glory Be.
5. Announce or call to mind the first Mystery to meditate upon and pray an Our Father.
6. Pray one Hail Mary on each of the ten beads
7. Finish the decade by praying a Glory Be and the Fatima Prayer. (**Note:** steps 5-7 together are called a decade).
8. Repeat steps 5-7 for the next four decades, meditating on the remaining Mysteries.



9. Holding the center piece, pray the Hail, Holy Queen and the concluding Rosary prayer. Finish by making the Sign of the Cross.

Rosary Prayers

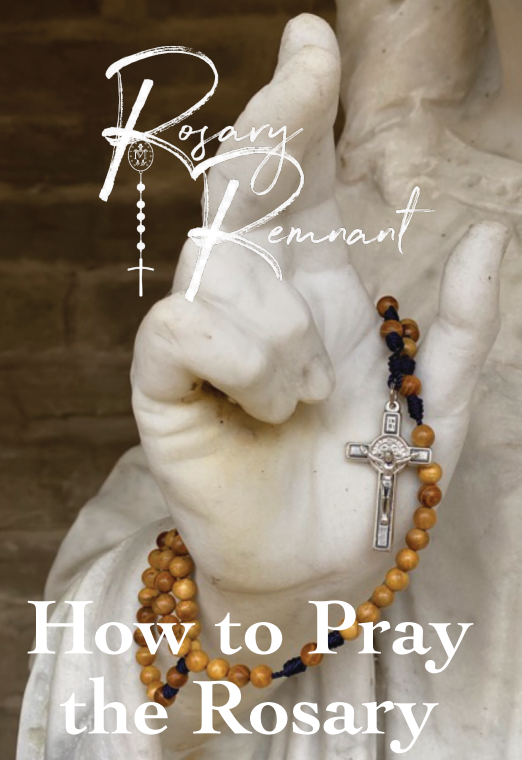

The Sign Of The Cross

In the name of the Father, and of the Son, and of the Holy Spirit. Amen. (Note: Make cross by touching with right hand — forehead [Father], torso [Son], left shoulder [Holy], right shoulder [Spirit])

Apostles Creed

I believe in God, the Father almighty, Creator of heaven and earth, and in Jesus Christ, his only Son, our Lord, who was conceived by the Holy Spirit, born of the Virgin Mary, suffered under Pontius Pilate, was crucified, died, and was buried; he descended into hell, on the third day he rose again from the dead; he ascended into heaven, and is seated at the right hand of God the Father almighty; from there he will come to judge the living and the dead. I believe in the Holy Spirit, the holy catholic Church, the communion of saints, the forgiveness of sins, the resurrection of the body, and life everlasting. Amen.

Our Father

Our Father, who art in heaven; hallowed be Thy name; Thy kingdom come; Thy will be done on earth as it is in heaven. Give us this day our daily bread; and forgive us our trespasses as we forgive those who trespass against us; and lead us not into temptation; but deliver us from evil. Amen.

Hail Mary

Hail Mary, full of grace. The Lord is with thee, blessed womb Jesus, Holy Mary, Mother of God, pray for us art thou among women, and blessed is the fruit of thy sinners, now and at the hour of our death. Amen.

Concluding Prayer

O God, whose only begotten Son, by His life, death, and resurrection, has purchased for us the rewards of eternal life, grant, we beseech Thee, that meditating upon these Mysteries of the Most Holy Rosary of the Blessed Virgin Mary, we may imitate what they contain and obtain what they promise, through the same Christ Our Lord. Amen.

Hail, Holy Queen

Hail, Holy Queen, Mother of Mercy, our life, our sweetness and our hope, to thee do we cry, poor banished children of Eve; to thee do we send up our sighs, mourning and weeping in this valley of tears; turn, then, most gracious Advocate, thine eyes of mercy towards us, and after this, our exile, show unto us the blessed fruit of thy womb; Jesus, O clement, O loving, O sweet Virgin Mary!

Fatima Prayer

O my Jesus, forgive us our sins, save us from the fires of hell. Lead all souls to heaven, especially those who have most need of your mercy.

Glory Be

Glory be to the Father, and to the Son, and to the Holy Spirit. As it was in the beginning, is now, and ever shall be, world without end. Amen.

Our Father

Our Father, who art in heaven; hallowed be Thy name; Thy kingdom come; Thy will be done on earth as it is in heaven. Give us this day our daily bread; and forgive us our trespasses as we forgive those who trespass against us; and lead us not into temptation; but deliver us from evil. Amen.

Hail Mary

Hail Mary, full of grace. The Lord is with thee, blessed womb Jesus, Holy Mary, Mother of God, pray for us art thou among women, and blessed is the fruit of thy sinners, now and at the hour of our death. Amen.

Folding Instructions

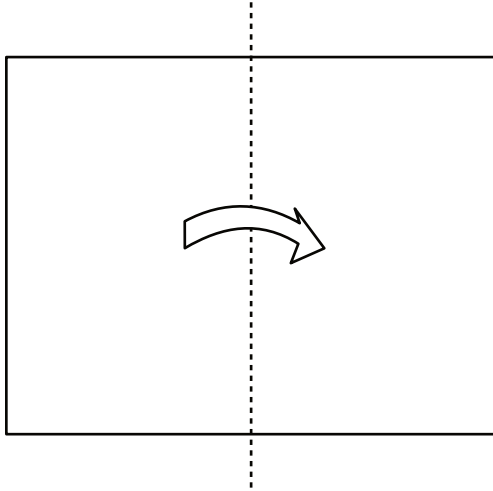

Step 1 Fold paper in half in the middle of long edge of the paper

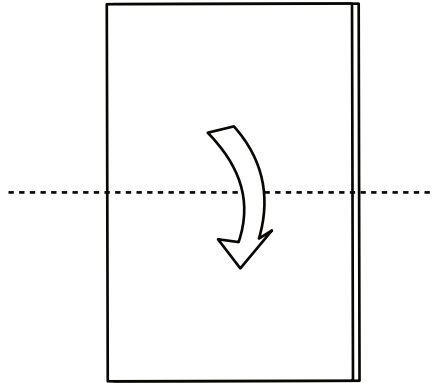

Step 2 Fold the paper in half again in a downward direction

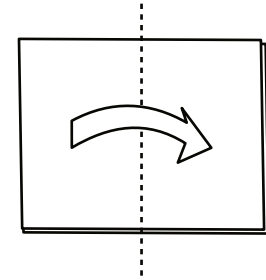

Step 3 Fold the paper in half one more time as shown. The paper should be folded to one-eighth of the original size.

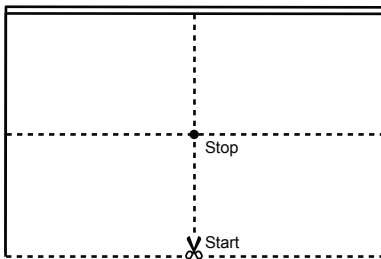

Step 4 Unfold the paper to half the original size and turn the paper so the paper is open at top and the crease is at the bottom (the dotted lines represent the creases). Cut from the bottom of the paper to the middle (from the START to the STOP points shown above).

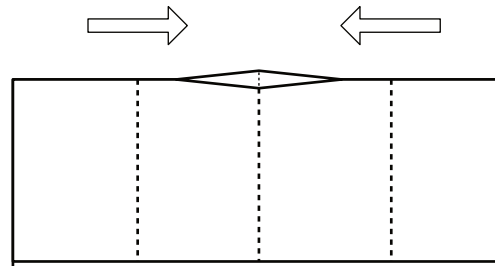

Side View

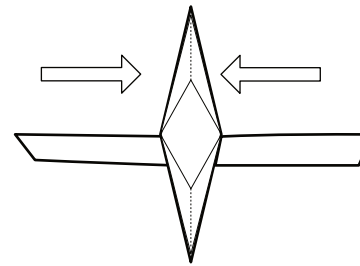

Top View

Step 5 Unfold the paper completely and refold in half along the short edge as shown. Push the paper inward so that the inside faces touch. It will look like a “plus sign” (+) if done correctly. The creases should form a booklet spine along the left edge.

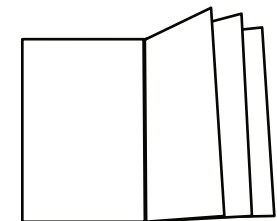

You now have a Rosary Instructions mini booklet to put in your pocket, place in a book, or give away!